



Product Overview Brochure

CMA 3000

All-In-One Field Tester for Fixed and Mobile Networks



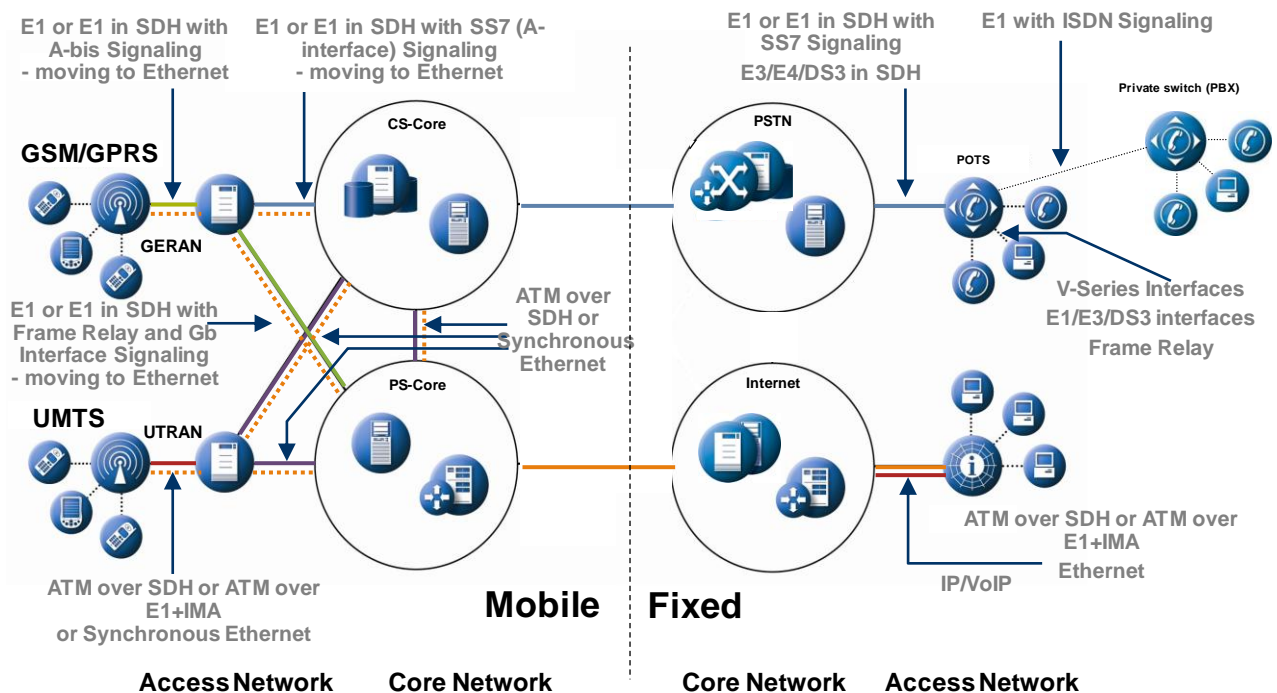

Fig. 1 The CMA 3000 is ideal for testing electrical and optical communication lines in the fixed-line and mobile access networks.

Field Testing Has Never Been Easier

CMA 3000 is Anritsu's next-generation portable, compact and user-friendly field tester. It's designed specifically for field technicians who install and maintain mobile-access and fixed-access networks. The CMA 3000 is a powerful tool for a wide range of applications, including fast first-aid troubleshooting to comprehensive, in-depth and all-layer analysis of transmission problems. Fault location is greatly facilitated by the high degree of portability of the robust CMA 3000. This allows you make measurements at any suitable measuring point.

Futureproof Design

The modular design provides you with a clear and cost-effective upgrade path. In its basic configuration the CMA 3000 is a full-featured 2 Mbps line transmission quality tester and analyzer. By adding options the CMA 3000 can test a large number of interfaces and technologies, including Ethernet up to 10 Gbps, SDH up to STM-64, ATM, E3, E4, V-series, Frame Relay and the Abis interface of GSM and GPRS networks. Other options turn the CMA 3000 into a very powerful signaling analyzer for GSM, GPRS/EDGE, SS7 and ISDN protocols.

Finally options allow the instrument to emulate VoIP or ISDN PRI calls.

Easy-to-use Interface

The intuitive user interface, with a large high-contrast color LCD display and easy-to-understand graphical symbols makes it easy to read and interpret measurement results. Through touch-screen operation you can easily customize measurement setups to fit your personal needs and work routines. You can store setups for particular applications in the instrument. For quick and easy distribution of standardized test setups within the organization you can transfer such setups between CMA 3000s. Remote operation is facilitated through an optional MS Windows® program simulating the instrument's front panel. With another option the CMA 3000 can be remotely controlled with command line scripts, whereby the instrument turns into a fast and reliable tool for automated testing in manufacturing environments.

The large memory of the CMA 3000 allows storage of a high number of measurement results. With the powerful and flexible report generator you can create .pdf files for selected measurement results. With these files you can provide professional documentation of test results to your customers.

The instrument is powered by rechargeable and replaceable intelligent high-capacity LiIon batteries, providing more than 10 hours of operation between recharges for the instrument in its basic configuration. The CMA 3000 can also be powered via an external mains adapter for long-term operation.

Key Features	Key Applications
<ul style="list-style-type: none"> • Simultaneous bi-directional monitoring of all supported interfaces • Powerful test of framed Nx64 kbps and unframed 2 Mbps systems • High flexibility through easy-to-install options <ul style="list-style-type: none"> ○ Ethernet interface (10Gbps, 1Gbps, 100Mbps, 10 Mbps) testing ○ 10G LAN PHY and 10G WAN PHY options ○ Service Activation Test (Y.1564) option ○ IP channel statistics ○ Ethernet Multistream, Stacked VLAN and MPLS test options ○ Synchronous Ethernet Test option ○ Ethernet VoIP test options ○ SDH interface: STM-1, STM-1/-4, STM-1/-4/-16, STM-64 ○ E3 interface, E4 interface options ○ ATM layer measurements ○ V-Series interfaces ○ Frame Relay testing ○ SS7, Abis and ISDN protocol analysis ○ ISDN PRI call emulation ○ FrontSim remote control ○ Remote control by scripting • LEDs for immediate line state indications • Large color touch-display • Battery-powered 	<p>Comprehensive out-of-service testing for:</p> <ul style="list-style-type: none"> • Installation • Provisioning • Propagation time analysis • Performance analysis • Physical line monitoring <p>In-service monitoring for:</p> <ul style="list-style-type: none"> • Fast troubleshooting • In-service error performance measurement <p>With Remote Control – Scripting option:</p> <ul style="list-style-type: none"> • Automated testing in <ul style="list-style-type: none"> ○ Manufacturing environments ○ Labs

Additional Information

More documentation including detailed specifications on the CMA 3000 and its options are available in electronic form. The following documents are available:

- Basic instrument spec sheet including information on the instruments 2 Mbps testing capabilities
- Ethernet options spec sheet including information on the IP channel statistics option, the Service Activation Test option, the Synchronous Ethernet Test option, the Ethernet Multistream test option, the Ethernet Stacked VLAN test option, the Ethernet MPLS test option and the Ethernet VoIP test options
- 10 G interface module spec sheet including information on 10Gbps, 1Gbps, 100Mbps, 10 Mbps Ethernet, the IP channel statistics option, the Service Activation Test option, the Synchronous Ethernet Test option, the Ethernet Multistream test option, the Ethernet Stacked VLAN test option, the Ethernet MPLS test option, the Ethernet VoIP test options and the STM-64 test option
- SDH options spec sheet including information on SDH testing up to STM-16, the E3 interface test option and on the E4 interface test option
- TCM option spec sheet
- ATM layer measurements spec sheet
- V-Series interfaces spec sheet
- Frame Relay testing spec sheet
- GSM/GPRS A-bis protocol analysis spec sheet
- ISDN protocol analysis spec sheet
- ISDN PRI call emulation spec sheet
- SS7 protocol analysis spec sheet
- FrontSim remote control spec sheet
- Remote control (scripting) spec sheet

Please contact your local Anritsu representation for an electronic copy of one or more of these documents. Or visit the Anritsu Web site at www.anritsu.com.

2 Mbps Testing

The basic CMA 3000 configuration, with its two 2 Mbps receivers and transmitters, supports framed and unframed testing and monitoring of 2 Mbps systems. This makes CMA 3000 the ideal instrument for measuring in- and out-of-service transmission quality.

To speed troubleshooting the CMA 3000 displays alarms and transmission link status on LED indicators. The instrument's two inputs allow instant monitoring of both sides of a line and comparison of simultaneously recorded results.

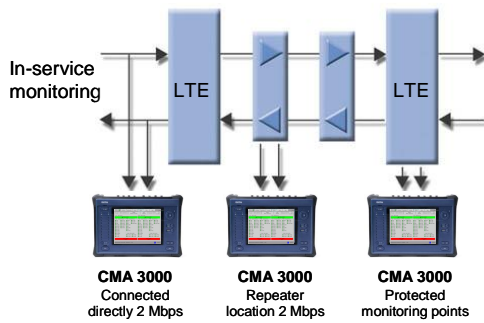

Fig. 2 With CMA 3000 you can perform in-service monitoring of a 2 Mbps line.

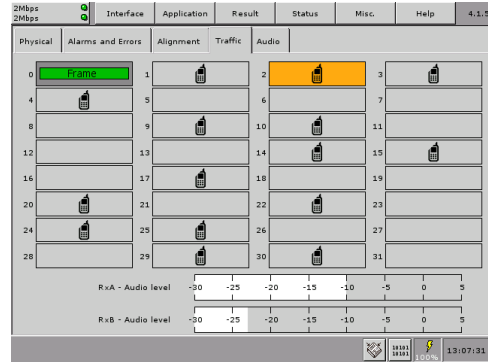

Fig. 3 Fast overview of traffic channel time slots.

The CMA 3000 2 Mbps status monitor is always active, providing essential information on the monitored transmission system, including:

- Line alarms on LED indicators with a trap facility
- Display of current input frequency and deviation
- Indication of input level
- Traffic channel usage
- Audio level in a traffic channel
- Propagation time monitor
- Listen-in on a traffic channel

Out-of-service or In-service Statistics

For installation/commissioning and troubleshooting of out-of-service of 2 Mbps lines the CMA 3000 provides powerful statistical measurements for Bit Error Rate (BER) testing. Statistics are also available for in-service analysis of the transmission-error performance of a line. Information on errors and alarms is collected in time-intervals as defined by you, and error-performance parameters (G.821/G.826/M.2100) are calculated.

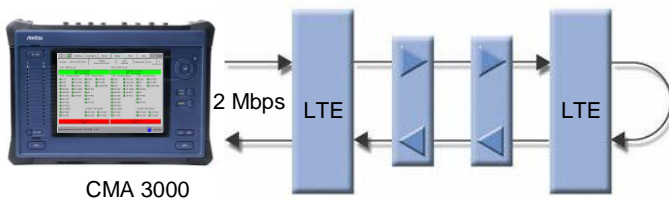

Fig. 4 Out of service testing of a 2 Mbps line with the CMA 3000.

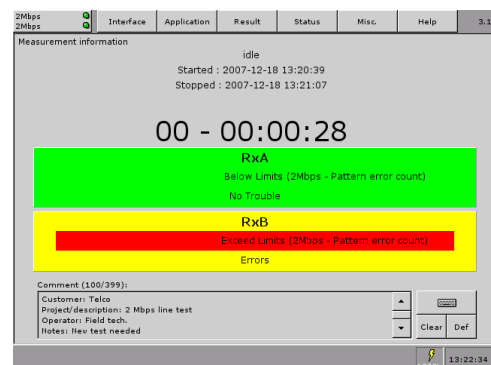

Fig. 5 The OK/Questionable/not-OK indication.

The Measurement Summary function gives you a rapid overview of a measurement via an 'OK/Questionable/not-OK' indication. You may also define thresholds for the 'OK/not-OK' levels. Histograms facilitate the tracing of errors over time.



Please refer to the dedicated spec sheet for detailed information on the CMA 3000 basic instrument.

Ethernet Test Options

When outfitted with the Ethernet interface measurement option, the battery-powered, easy-to-use and portable Anritsu CMA 3000 is a comprehensive solution for testing and measuring LAN communication lines. It's easy to configure the CMA 3000 Ethernet options to your requirements. A dual port module is available for testing Ethernet 10/100 interfaces. Or, you can have a dual-port Ethernet 10/100/1000 test module equipped with electrical and optional optical interface ports. Finally a 10/100 Mbps 1/10G test module is available, as single or dual port at the 10 Gbps rate and dual port at the lower rates.

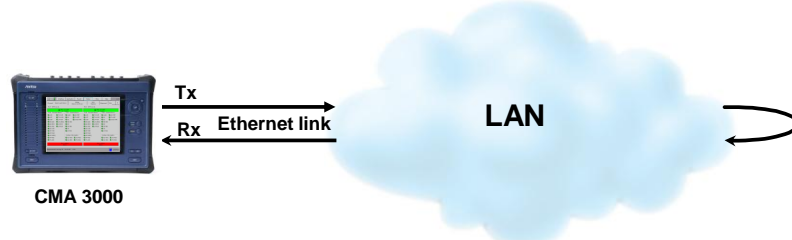

Fig. 6 Out-of-service testing of an Ethernet link using the CMA 3000.

Transmitters and receivers permit out-of-service testing for installation, commissioning and Quality of Service (QoS) verification while a pass-through mode enables in-service monitoring for both fast troubleshooting and detailed analysis of the live traffic on the line. This makes CMA 3000 the ideal instrument for measuring in- and out-of-service transmission quality.

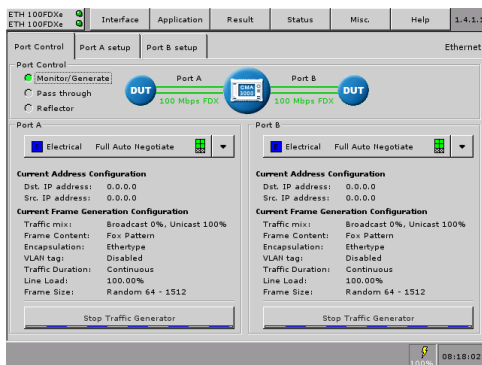

Fig. 7 The operation of the CMA 3000 is made easy through an intuitive graphical user interface.

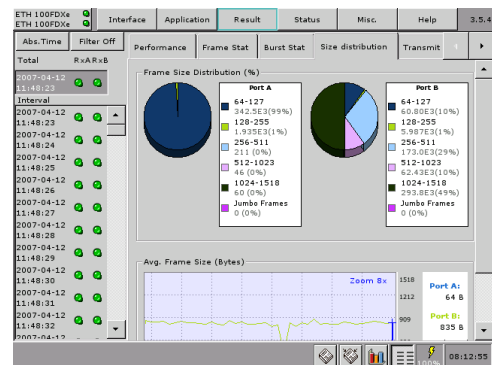

Fig. 8 Statistics are presented in tables and easy to understand graphs.

Installation, Commissioning and QoS Verification

For installation, commissioning and QoS verification CMA 3000 provides powerful and flexible traffic generation capabilities, allowing you to easily test the network under various conditions, including generation of VLAN tagged traffic. Performance and QoS statistics are presented in tables and graphs facilitating results interpretation. Through preprogrammed thresholds, CMA 3000 can highlight abnormal conditions on the tested line.

RFC 2544 Analysis

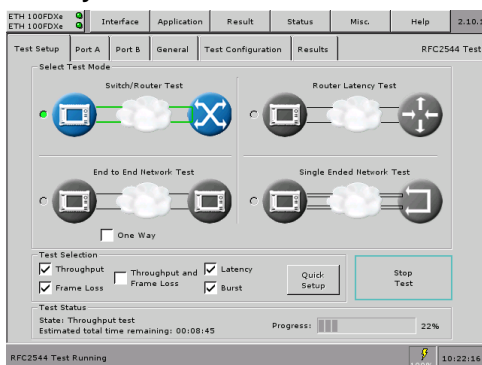

Fig. 9 Intuitive configuration of the RFC 2544 tests

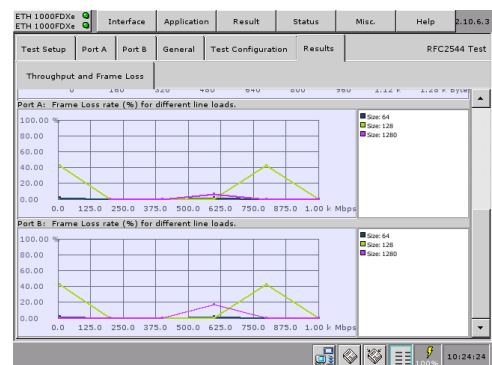

Fig. 10 CMA 3000 presents RFC 2544 results in graphs or tabular format

The IETF RFC 2544 “Benchmarking Methodology for Network Interconnect Devices” defines a number of tests to be used for describing the performance characteristics of these network devices. With the CMA 3000 Ethernet options, testing of performance parameters, such as throughput and frame loss, latency, packet jitter and burstability, in compliance with RFC 2544 is straightforward. CMA 3000 automates the testing procedure while still allowing you to configure the test to be as

thorough as needed. To get full information on the performance of both sides of a line or to test asymmetrical links like xDSL links, the end-to-end test mode allows two CMA 3000 to work together in a master-slave setup whereby the user can control both units and inspect the results of the test from both units on the master instrument.



Fig. 11 RFC 2544 testing of asymmetrical Ethernet links using two CMA 3000s. Two links can be tested simultaneously

In-service Troubleshooting

For fast troubleshooting the CMA 3000 status monitor provides essential information on the monitored transmission system, including: Line alarms on LED indicators with a trap facility, display of current line status, electrical cable test facility and indication of main link performance parameters: Utilization, Throughput and Errored frames.

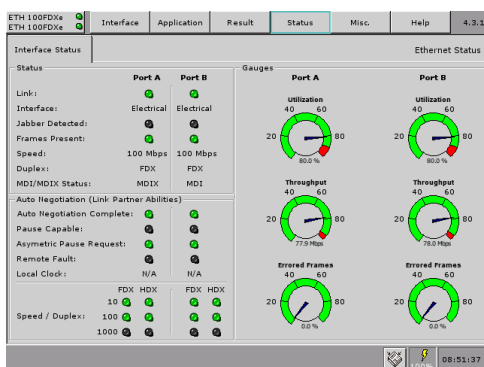

Fig. 12 Interface status indicators for a quick overview of the line's condition

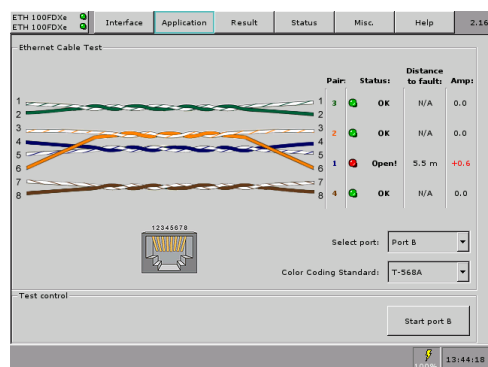

Fig. 13 The CMA 3000s cable test facility makes it easy to identify failures on electrical cables like short circuits or breaks of a wire pair. The cable test facility also indicates the distance from the instrument to the fault.

Detailed In-service analysis

CMA 3000 can analyze live traffic in details by presenting statistics on the main performance indicators for a monitored line. To facilitate the analysis of data it's possible to define threshold values for a number of parameters. CMA 3000 uses the thresholds to color-highlight results outside the acceptable range. This is also indicated on the LEDs of the instrument.

IP Channel Statistics Option

For further analysis of live IP traffic on the Ethernet line CMA 3000 can be equipped with the IP channel statistics option. This option provides detailed information on the traffic on the monitored line for up to 232 individual channels, identified by Ethernet addresses, IP addresses, VLAN tags or MPLS labels. This allows you to identify whether a channel that loads the line heavily, sends many errored frames or uses the line in an inefficient way.

Service Activation Test option

The Ethernet Service Activation Test option for the CMA 3000 allows the user to conduct tests in accordance with Y.1564 for up to 8 services. The test is typically done with two CMA 3000s performing the Service Activation Test in a Local-Remote setup. It can however also be done with one unit and a far-end loop back device. When the service activation test is done in the Local-Remote setup with two CMA 3000s you control the test from the local instrument: It transfers relevant information to the remote unit and after the test is completed you can see results from both units on the local instrument. Easy to understand graphical symbols make it very fast to see if the tests passed. If further analysis is required the information presented can be expanded to show all details of each test. For measurements of Frame Transfer Delay (FTD) between two CMA 3000s, a GPS add-on option can provide true one-way measurements of Frame Transfer Delay.

Synchronous Ethernet Test option

The Synchronous Ethernet Test option for the CMA 3000 allows the user to conduct Test and analysis of the Synchronous Ethernet technologies SyncE (ITU-T G.826x) and of IEEE 1588 v2 (PTP) including ITU-T G.8265.1 IEEE 1588 v2 profile for telecommunication, depending on the installed Ethernet interface option.

The SyncE (ITU-T G.826x) functionality includes detection and generation of G.826x Synchronization Status Messages (SSM) for verification of the SyncE network. An alarm will indicate if SSMs are not detected. For detailed analysis the instrument can log SSMs for transfer to a PC via the FrontSim option for decode with Wireshark.

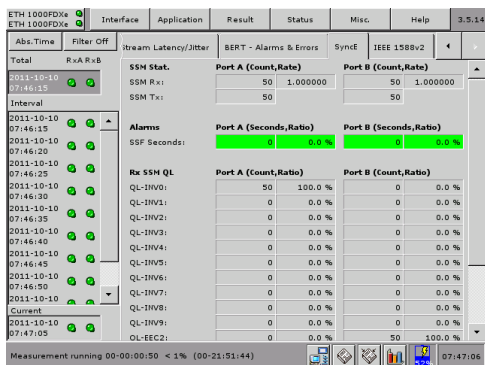

Fig. 14 Comprehensive statistics on SSM QL messages and values

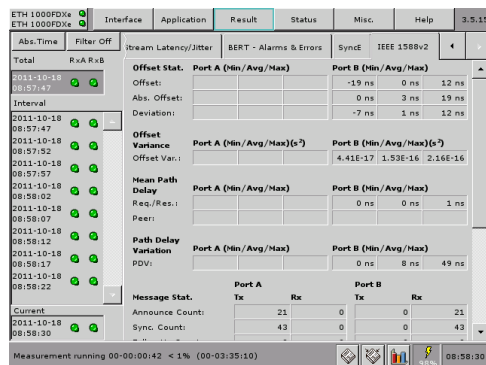

Fig. 15 Comprehensive IEEE 1588 v2 statistics on offset and offset variance, path delay variation, messages and clock state transitions

The IEEE 1588 v2 (PTP) functionality includes the CMA 3000 to act as a master using the internal instrument clock or a GPS signal (when present) as clock source. Alternatively the instrument can act in slave mode, including choosing the best master wall clock and constantly adjusting the clock. During a test the user will get comprehensive statistics on IEEE 1588 v2. An alarm is generated if synchronization messages are not received within a certain time.

Ethernet Multistream Option

The Ethernet multistream option for the CMA 3000 allows the user to test a congested networks ability to transport high priority traffic rather than lower priority traffic. The user can activate up to 8 streams with different priority settings on the Ethernet line and detect how they are affected by frame loss through the network.

Stacked VLAN Option

Stacked VLAN is increasingly used in several types of Ethernet based networks. With a CMA 3000 equipped with Ethernet and Stacked VLAN options the user has a powerful tool for testing such networks. The Stacked VLAN option supports up to 8 levels of VLAN tags.

MPLS Option

MPLS (Multi Protocol Label Switching) allows efficient routing of traffic in packet based networks. With a CMA 3000 equipped with Ethernet and MPLS the user has a powerful tool for testing with this type of traffic.

VoIP Test Options

The wide deployment of VoIP makes it essential for field technicians to have a tool that can test VoIP connections. When testing VoIP first of all connectivity must be checked. Once this is done, verification of the quality is essential.

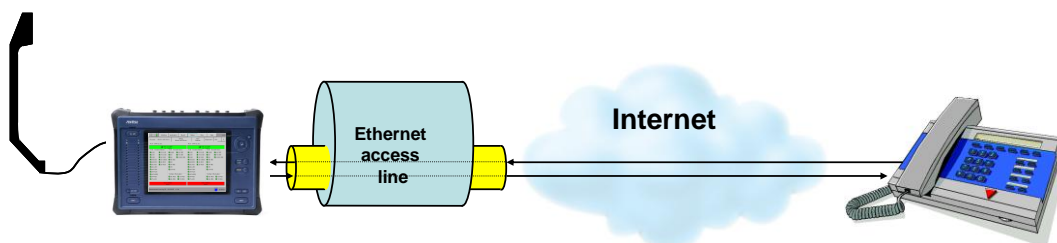



Fig. 16 Basic VoIP connectivity is verified by calling another party using the CMA 3000's VoIP functionality.

For VoIP testing the instrument can establish a call and answer incoming calls. By connecting an analogue telephone to the CMA 3000 the user can make a conversation with the called/calling party. Statistics collected during the call will inform the user on the performance of the communication line used for the call. Based on this an add-on option can present voice quality information in terms of Mean Opinion Score (MOS) and R-factor values for one call at the time.

To make a realistic test case the instrument can generate or receive up to 8 calls simultaneously. These calls can be made on one or both test ports in the Ethernet option. If the instrument is also equipped with the Ethernet Multistream option, each of the 8 calls can be assigned to a stream, f.inst. allowing individual configuration of priority for the calls.

 Please refer to the dedicated spec sheets for detailed information on the CMA 3000 Ethernet options, the IP channel statistics option, the Ethernet Multistream option, the Synchronous Ethernet Test option, the Ethernet Stacked VLAN test option, the Ethernet MPLS test option and the VoIP options.

SDH Test Options

When equipped with the SDH test options, the CMA 3000 is a powerful and easy-to-use tool for testing SDH and PDH systems. The SDH option for rates up to STM-16 is very flexible, with two electrical receivers and one electrical transmitter in its basic form. Another option supports STM-64. They can be equipped with one or two optical modules. With two optical modules, the instrument supports simultaneous bi-directional monitoring of SDH lines. This makes CMA 3000 ideal for both in- and out-of-service transmission-quality measurements.

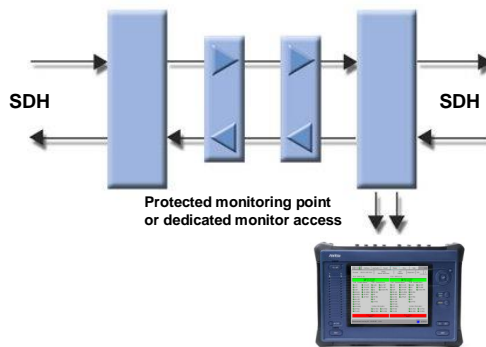

Fig. 17 The dual receive capability on SDH interfaces makes the CMA 3000 ideal for in-service analysis of SDH systems.

The intuitive user interface allows you to easily read and interpret important information from the SDH signal. For fast troubleshooting, the CMA 3000 displays alarms and transmission link status on LED indicators. In addition, the trouble scan feature provides a fast approach to examining the SDH signal for major problems. CMA 3000 automatically configures to the received SDH signal, eliminating lengthy instrument setup. The powerful 2 Mbps analysis capabilities of the basic CMA 3000 enables you to analyze a demultiplexed 2 Mbps signal embedded in an SDH signal.

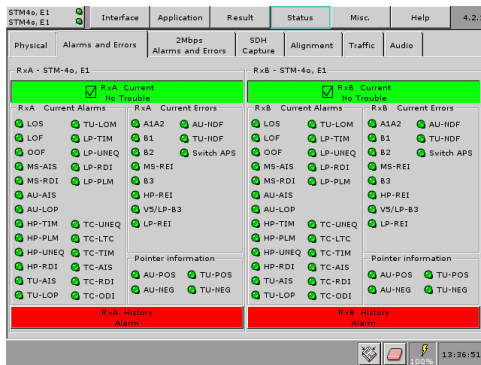

Fig. 18: The CMA 3000 gives you a quick overview of errors and alarms of both sides of the SDH line.

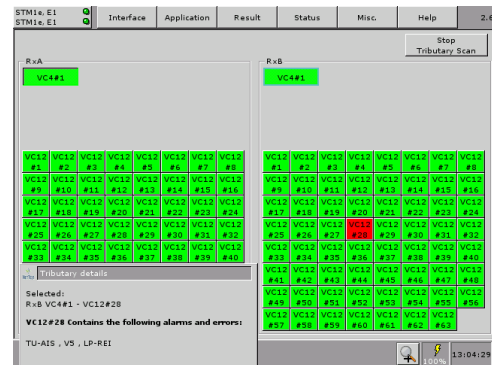

Fig. 19: The tributary scan feature gives you a quick overview of the tributaries of the monitored line with color identification of problems.

Speeds SDH Troubleshooting

The CMA 3000 status monitor allows you to speed troubleshooting, as the status monitor is always active providing essential information on the monitored transmission system. In-depth trouble analysis can be done using the instrument's pointer movement graph. A special test feature provides easy testing of APS (Automatic Protective Switching) to allow identification of maximum switchover time during the test. Should the result be above the user-defined threshold you will receive an indication of the problem. For monitoring purposes you may connect the CMA 3000 using optical splitters or special test interfaces. If neither is available, you can use the CMA 3000 through-mode to access the signal.

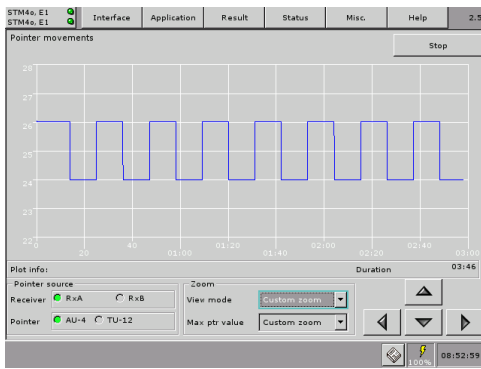

Fig. 20 The pointer graph allows a detailed analysis of pointer movements in the monitored SDH signal.

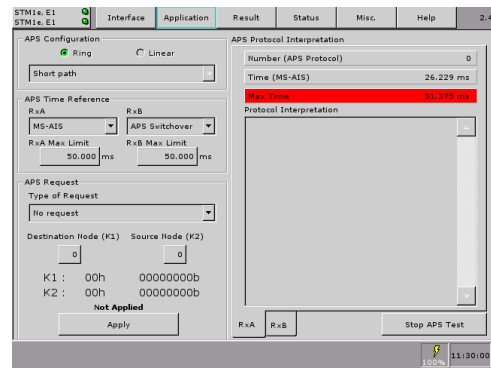

Fig. 21 The dedicated APS test application makes it easy to find the maximum APS switchover time.

Out-of-service or In-service SDH Statistics

For installing/commissioning and out-of-service troubleshooting of SDH lines the CMA 3000 provides powerful statistical measurements for Bit Error Rate (BER) testing. Statistics are also available for in-service analysis of the transmission-error performance of a line together with information on pointer operations. G.826, G.828, G.829 or M.2100 error-performance parameters are calculated for the measurement. The result is highlighted in easy-to-understand color indications. During installation/commissioning and stress testing of network elements you can control the signal transmitted by the CMA 3000. When generating an SDH signal the instrument provides you with great flexibility for injecting errors, alarms, pointer operations and overhead byte changes into the transmitted signal. In addition, you can deviate the frequency of the transmitted signal from nominal to test a receiver's ability to handle signals that are out of specifications.



Please refer to the dedicated spec sheet for detailed information on the STM-1/-4/-16 , E4 and E3 options and to the 10 G interface module spec sheet for detailed information on STM-64.

TCM Test Option

It's possible to further test SDH systems by adding the Tandem Connection Monitoring (TCM) option to a CMA 3000 with SDH option installed. The TCM option contains very powerful features for testing and monitoring TCM systems in SDH networks. As CMA 3000 can be outfitted to support bi-directional in-service monitoring you can inspect TCM parameters for both sides of a line simultaneously. This allows you to analyze the overall transmission quality of the monitored part of the line in the fastest way possible. For out-of service testing and verification of the TCM system CMA 3000 includes features to inject the various conditions that provoke TCM events.



Please refer to the dedicated spec sheet for detailed information on the CMA 3000 TCM test option.

E4 Test Option

A CMA 3000 equipped with an SDH option can get an E4 option added for testing with E4 streams. The E4 signal can also be mapped into the SDH signal. Installing/commissioning and out-of-service troubleshooting of E4 lines is supported in the CMA 3000 by statistical measurements for Bit Error Rate (BER) testing. Statistics are also available for in-service analysis of the transmission-error performance of an E4 line and G.826 or M.2100 error-performance parameters are presented.



Please refer to the dedicated spec sheet for detailed information on the CMA 3000 SDH, E4 and E3 options.

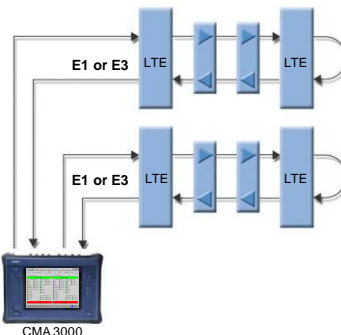

Fig. 22 The CMA 3000 can test two E1 or E3 lines simultaneously.

E3 Test Option

The CMA 3000 can be equipped with an E3 option for testing with 34 Mbps and unframed 45 Mbps streams. If the E3 option is installed together with the SDH option, the 34/45 Mbps signal can be mapped into the SDH signal. If the SDH option is not installed, installation of the E3 option makes the CMA 3000 a powerful tool for testing at 34 Mbps, 45 Mbps and 2 Mbps rates. Installing/commissioning and out-of-service troubleshooting of E3 lines is supported in the CMA 3000 by statistical measurements for Bit Error Rate (BER) testing. Statistics are also available for in-service analysis of the transmission-error performance of a 34 Mbps line and G.826 or M.2100 error-performance parameters are presented.



Please refer to the dedicated spec sheet for detailed information on the CMA 3000 SDH, E4 and E3 options.

ATM Test Options

When equipped with the ATM test options, the CMA 3000 is a powerful and easy-to-use tool for testing ATM channels in SDH and PDH systems. The ATM option allows both active testing with one transmitter and one or two receivers and simultaneous bi-directional monitoring of ATM traffic with two receivers. This makes CMA 3000 the ideal instrument for both in- and out-of-service transmission-quality measurements.

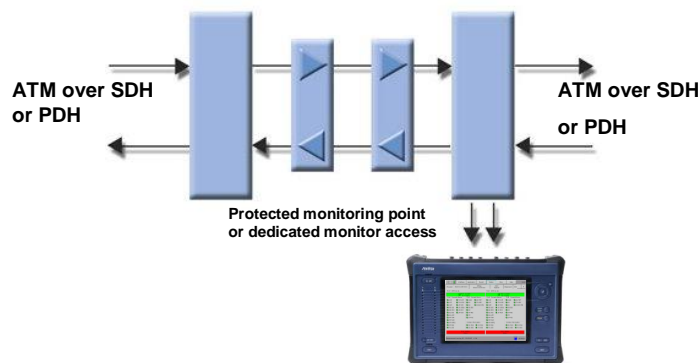

Fig. 23 The bi-directional monitoring capability of the CMA 3000 makes it ideal for in-service troubleshooting of ATM connections.

The CMA 3000 status monitor allows quick troubleshooting, as it is always active providing essential information on the monitored transmission system and ATM traffic on top of that. Through bidirectional monitoring the user can quickly verify that both sides of the ATM connection are working properly. The ATM scan facility in the CMA 3000 gives a quick overview of the active virtual channels in the monitored ATM traffic. Up to 150 channels can be identified.

In-service ATM Statistics

For in-service troubleshooting of ATM channels on SDH links the CMA 3000 provides powerful bidirectional statistical measurements of general ATM alarms and errors and Virtual Path (VP) OAM F4 and Virtual Circuit (VC) OAM F5 alarms for one selected foreground channel.

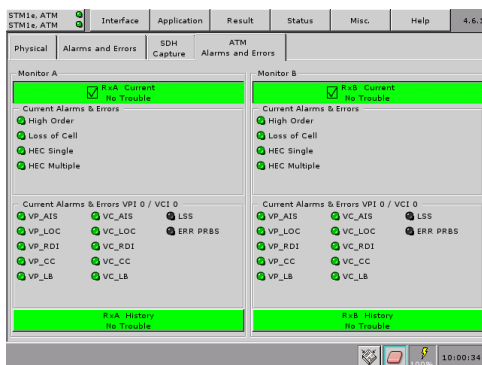

Fig. 24 The CMA 3000 gives you a quick overview of errors and alarms of both sides of the ATM connection.

Transmitter <SDH>	Receiver A <SDH>	Receiver B <SDH>	VP/VC Filter	Scan	ATM
ATM Receiver A					
VP/VC Filter off	<input checked="" type="checkbox"/> Kbps	<input checked="" type="checkbox"/> Utilize	VP/VC Filter off	<input checked="" type="checkbox"/> Kbps	<input checked="" type="checkbox"/> Utilize
VPI	VCI	Rate(cps)	Rate(Kbps)	Utilize(%)	
5	8	17661	7488.26	5.00	
5	10	7064	2995.14	2.00	
5	12	3532	1497.57	1.00	
5	13	1766	748.78	0.50	
5	15	3532	1497.57	1.00	
5	16	1413	599.11	0.40	
7	5	707	299.77	0.20	
7	6	3532	1497.57	1.00	
7	7	3532	1497.57	1.00	
7	8	1766	748.78	0.50	
7	9	353	149.67	0.10	
7	11	3885	1647.24	1.10	
7	12	1060	449.44	0.30	
7	14	3532	1497.57	1.00	
Apply selected to ATM Receiver A foreground					
ATM Receiver B					
VP/VC Filter off	<input checked="" type="checkbox"/> Kbps	<input checked="" type="checkbox"/> Utilize	VP/VC Filter off	<input checked="" type="checkbox"/> Kbps	<input checked="" type="checkbox"/> Utilize
VPI	VCI	Rate(cps)	Rate(Kbps)	Utilize(%)	
5	8	17661	7488.26	5.00	
5	10	7064	2995.14	2.00	
5	12	3532	1497.57	1.00	
5	13	1766	748.78	0.50	
5	15	3532	1497.57	1.00	
5	16	1413	599.11	0.40	
7	5	707	299.77	0.20	
7	6	3532	1497.57	1.00	
7	7	3532	1497.57	1.00	
7	8	1766	748.78	0.50	
7	9	353	149.67	0.10	
7	11	3885	1647.24	1.10	
7	12	1060	449.44	0.30	
7	14	3532	1497.57	1.00	
Apply selected to ATM Receiver B foreground					

Fig. 25 The user can quickly get an overview of the active virtual channels in the monitored ATM traffic through the ATM scan facility in the CMA 3000.

Statistics are also available for in-service analysis of up to 30 ATM channels, identified by their VP/VC identifiers (VPI/VCI). The user can compare one selected parameter for all channels or see all parameters for one channel. The parameters include

User cells, User Congestion cells, OAM cells and Resource Management cells. A number of traffic descriptor parameters are also measured: Peak Cell Rate (PCR), Sustainable Cell Rate (SCR), Minimum Cell Rate (MCR), Maximum Burst Size (MBS) and Cell Delay Variation Tolerance (CDVT).

The instrument can monitor status and synchronization cells for 2 Mbps lines running IMA (Inverse Multiplexing for ATM). Hereby it is easy for the user to check the status of the 2 Mbps lines that are used in the IMA connection.

Out-of-service ATM Tests

During installation/commissioning and stress testing of network elements you can control the signal transmitted by the CMA 3000. UNI and NNI ATM traffic can be generated from E1 rate up to STM-4 rate (VC4-4c). The instrument can generate ATM cells in one foreground channel for the actual test and add traffic in up to 14 background channels to emulate a realistic signal for testing the ATM network. The instrument offers a selection of traffic profiles in the foreground channel, allowing emulation of different types of traffic. The instrument can also generate test signals defined in ITU-T rec. O.191 for measurement of Quality of Service (QoS). The QoS parameters include information on lost or misinserted cells, delay and delay variation. For testing of the lower PDH or SDH layer the CMA 3000 provides you with great flexibility for injecting errors and alarms and for SDH making pointer operations and overhead byte changes into the transmitted signal.



Please refer to the dedicated spec sheet for detailed information on the CMA 3000 ATM options.

The Easy Way to Test V-series Interfaces – V-series Interface Test Option

When equipped with the V-series interface measurement option, the portable, easy-to-use and compact CMA 3000 offers test and measurement of legacy V-series data transmission lines, in addition to the full-featured 2 Mbps transmission testing provided by the basic instrument. The supported interfaces are: RS-232C/V.24, X.21/V.11, V.35, RS-449/V.36 and RS-530.

Key applications of the V-series test interface option are: Installation testing, rapid in-service diagnostics and troubleshooting, transmission line performance analysis, mux/demux testing and drop-and-insert to other equipment for further analysis. In order to test the data interfaces on a transmission line you may set up the CMA 3000 as a DTE. You may also configure the CMA 3000 as a DCE to test the terminal equipment. The dual-receive setting for the V-series data interfaces allows you to monitor the control circuits on the line. This makes CMA 3000 the ideal solution for both in-service and out-of-service transmission measurements.

Comprehensive Out-of-Service Testing

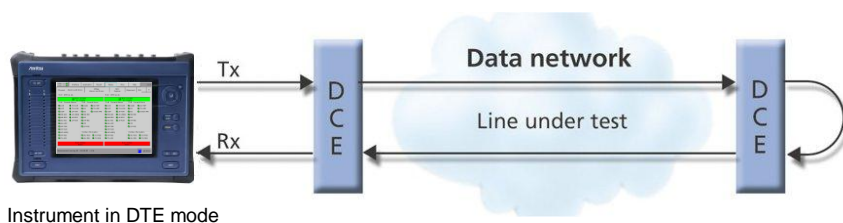

Fig. 26 V-series interface transmission line testing.

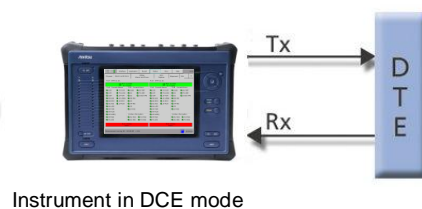

Fig. 27 Data terminal testing.

CMA 3000 supports basic BER testing for installation, commissioning and stability tests. The performance of the system under test is evaluated on the basis of BER measurements, with a loop-back at the far end of the tested line. The graphical histogram presentation provides an overview of a long measurement and makes it easy to identify error periods.

Mux/Demux Testing

You can use the CMA 3000 for comprehensive testing of multiplexers and demultiplexers that insert and extract data lines to and from 2 Mbps systems. BER testing is used for evaluating the performance of the network element under test with the CMA 3000 connected to both the data line and the 2 Mbps side of the network element.

Propagation Time

Propagation time can be measured when the CMA 3000 transmits a PRBS and the pattern is looped back to the instrument. This enables you to verify that delays introduced by network equipment and transmission lines are below specified limits.

Control Circuit Monitoring and Analysis

For analysis of handshake problems, CMA 3000 can monitor the control circuits on a line. The instrument's LEDs present the current status of the most important control circuits. Current status of all relevant control circuits can be inspected on the color display. For easy examination of timing relations, you can log changes in the control circuit states on the line. When the instrument is in DTE or DCE mode you can define the state of the control circuits output from the instrument.

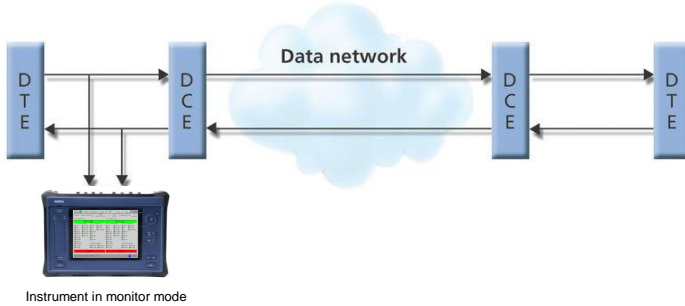

Fig. 28 In-service monitoring of V-series interfaces with the CMA 3000.

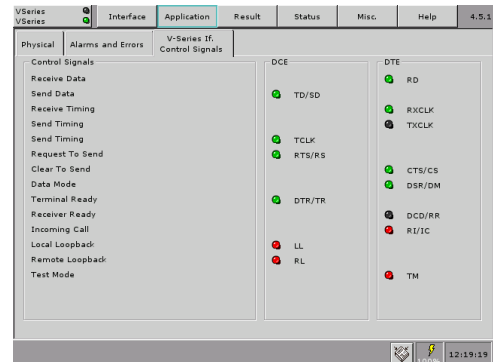

Fig. 29 Detailed information on control circuits is visualized on the display.

Drop-and-insert Testing

For testing with external equipment, the CMA 3000 field tester can drop and insert signals between its 2 Mbps interfaces and a selected data interface. Two modes are available:

- A normal drop-and-insert mode for testing applications
- A dual-drop mode for monitoring applications



Please refer to the dedicated spec sheet for detailed information on the CMA 3000 V-series interface test option.

Rapid Turn up of Frame Relay Lines with the Frame Relay Option!

When outfitted with the frame relay test option, the battery-powered Anritsu CMA 3000 is an easy-to-use, portable field test instrument for the installation, operation and maintenance of frame relay services on 2 Mbps and V-series interface lines. The frame relay option provides you with powerful tools for turn up of frame relay lines through the simulation of frame relay data packets with user-defined characteristics. The measurement facilities gives you essential information on the line quality. For in-service analysis and troubleshooting, you have access to extensive frame relay statistics. Using the the CMA 3000 frame relay channel scan feature you can quickly identify multi-time slot frame relay channels.

DLCI and LMI Information

To establish the logical configuration of the link, CMA 3000 generates a LMI Status Inquiry Message, requesting "Full Status" at user-defined intervals. The response from the network helps you verify the correct setup of activated DLCIs on the link.

CMA 3000 derives network information from the Full Status reports and displays it, allowing you to inspect the network parameters. The CMA 3000 also analyzes the LMI Status messages on the monitored line displaying the results in such way that you can check if the basic surveillance of the frame relay connection works properly.

With the frame relay emulation capability that supports DLCI tests emulation with user-defined setup parameters you can test the frame relay connection for a selected DLCI. These tests allow you to test end-to- end connectivity as well as the network's ability to handle various frames lengths, frame contents and output utilizations.

Bit Error Rate Testing is carried out with a user-defined test pattern in the payload. If required, the emulation testing inserts frame numbering into the test frames in order to determine if frames have been lost. This test can be conducted with or without LMI emulation in the background.

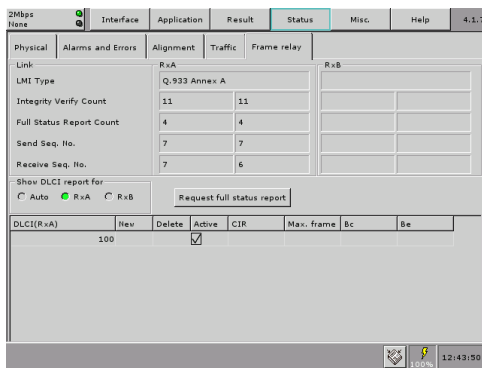

Fig. 30 Frame relay LMI information with LMI counts and sequence numbers for both sides of a frame relay line and status for up to 50 DLCIs.

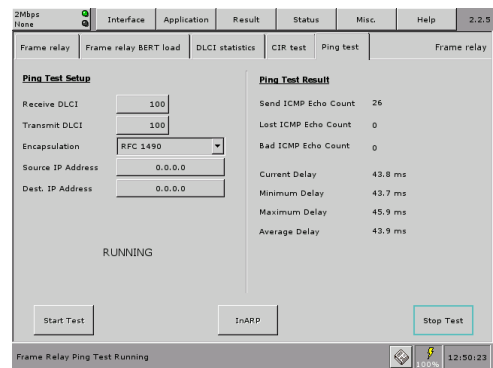

Fig. 31 Ping test of connectivity and delay.

PING Test and InARP

The CMA 3000 can perform a "PING" test, send a proper response to received "PING" patterns and then measure the round-trip delay. It's possible to perform this test with or without LMI emulation in the background. If the IP address of the destination node is unknown, CMA 3000 can send out an InARP IP address request.

Frame Relay Statistics

With CMA 3000's extensive frame relay statistics you can perform in-service analysis and troubleshooting of the monitored frame relay connection. The frame relay statistics provide valuable and detailed information for up to 50 individual DLCIs (of which 8 may be user-defined) and a total for all DLCIs on the monitored line. The CMA 3000 monitors a large number of parameters for these DLCIs simultaneously. For 2 DLCIs and the total for all DLCIs histograms are available, making it easy for you to analyze changes in traffic pattern over time. The frame relay statistics visualizes the frame relay connection.

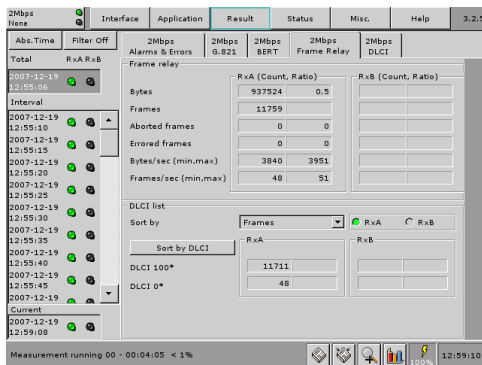

Fig. 32 Extensive statistics provides overview of the traffic during frame relay emulation.



Fig. 33 The CMA 3000 monitors a large number of parameters for up to 50 DLCIs simultaneously.

CIR Test

The Committed Information Ratio (CIR) is agreed between the customer and the frame relay network operator. The CIR establishes the data rate that the network operator commits to transport through the network. It's therefore vital to verify the CIR of a frame relay circuit. The CMA 3000 includes an automatic test of the CIR. The instrument will also estimate the CIR value for the monitored DLCIs when measuring live frame relay traffic.



Please refer to the dedicated spec sheet for detailed information on the CMA 3000 Frame Relay option.

Easy Field Testing with GSM/GPRS A-bis Options

Equipped with the GSM/GPRS Abis protocol decode options, the battery-powered CMA 3000 is an easy-to-use, portable field test instrument for the installation, operation and maintenance of Abis interfaces on 2 Mbps lines in GSM/GPRS networks. It's also possible to outfit the CMA 3000 with the Gb interface protocol decode option and the powerful frame relay option to support the installation, operation and maintenance of Gb interfaces on 2 Mbps lines in GPRS/EDGE networks. Yet other options allow you to use the CMA 3000 for analyzing other 2 Mbps interfaces in GSM/GPRS networks.

KEY APPLICATIONS

- Installation testing
- Rapid in-service diagnostics and troubleshooting
- Signaling analysis and troubleshooting
- Identification of frame relay channels on the Gb interface
- Traffic channel usage
- Listen in on a traffic channel
- GSM radio quality parameters

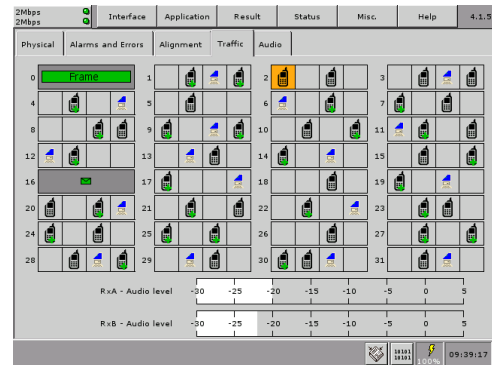

Fig. 34 The Abis status display.

Key features of the GSM/GPRS Abis protocol decode options includes in-depth analysis of GSM/DCS 1800 Abis, GPRS Abis and GPRS/EDGE Gb signaling. Also supported are signaling channel traffic statistics, traffic channel overview and decode of GSM voice encodings. You can automatically configure the CMA 3000 to the monitored 2 Mbps line, including identification of signaling channels. When equipped with SDH interface options you can also analyze GSM/GPRS Abis and Gb interfaces on 2 Mbps lines embedded in SDH signals.

Abis Interface Status Display

With the CMA 3000 you get a quick overview of the activity on the GSM/GPRS Abis interface, as the instrument provides information on the contents of the sub-channels on the monitored Abis interface in the GSM/GPRS Abis status display. Sub-channels used for GPRS and HSCSD are indicated together with traditional GSM speech channels in the GPRS Abis status display. Sub-channels used for AMR encoded speech are also indicated.

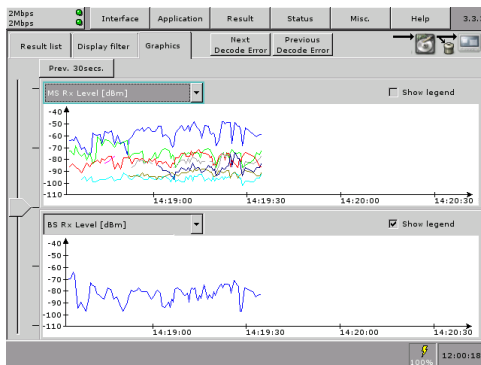

Fig. 35 Graphical presentation of GSM Abis interface MEASUREMENT_RESULT message information.

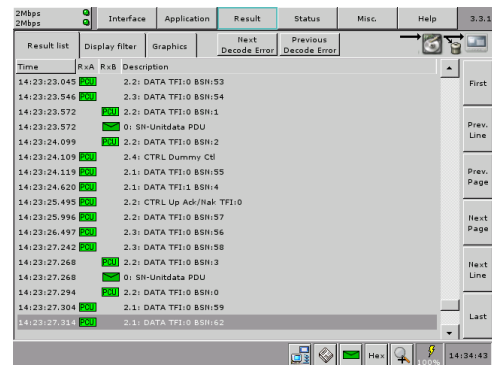

Fig. 36 The result list display of GPRS Abis signaling messages with both PCU frames (marked with PCU) and assembled LLC level messages (marked with a green envelope).

Protocol Analysis

During installation or troubleshooting CMA 3000 provides valuable and detailed information on the signaling by collecting signaling messages from the GSM/GPRS Abis interface and the Gb interface. For GPRS Abis the instrument captures and presents the basic PCUs and the assembled messages at the LLC layer on the GPRS Abis interface. For unencrypted messages all layers of signaling messages (GMM/SM or SMS) are decoded. This allows you to make a detailed analysis of the signaling problems in the network.

The CMA 3000 presents the recorded information in different ways: The Result List gives a one-line indication of each message for a rapid overview of the signaling information. This makes it simple to identify the input on which the message was detected, and subsequently you can easily detect message sequences.

The result list presentation can be expanded to show relevant parts of the messages, making it easy to identify the information carried. The contents of a message can also be shown, either presenting the main information elements or all parts of the signaling message and the hexadecimal values for detailed inspection and analysis.

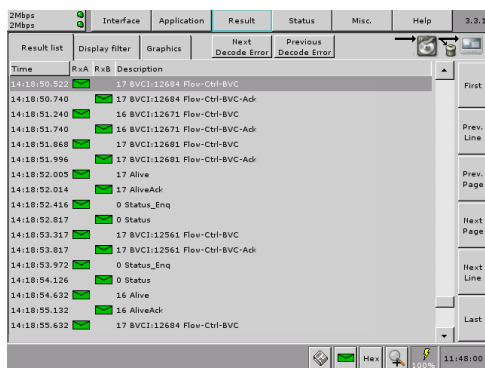

Figure 37 The Result List overview presentation of Gb interface messages.

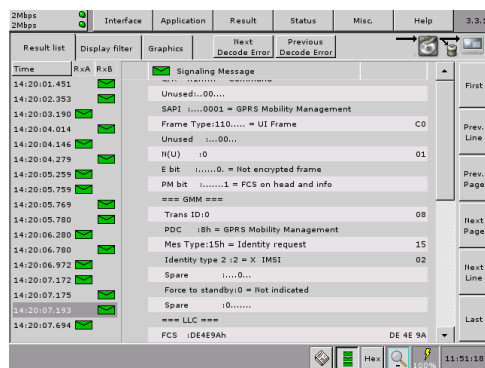

Figure 38 The detailed contents of an unencrypted Gb interface signaling message.

Signaling Statistics

The CMA 3000's signaling statistics provide data on the total traffic load and the quality of the signaling link. For network optimization the GSM Abis Layer 3 and DTAP message type statistics opens many possibilities to the user. Call completion can be examined by comparing the count of SETUP messages on one side of the line with CONNECT messages on the other side of the line. Release cause statistics are also available for the Abis protocols.

On GPRS Abis the load of various PCU frame types can be examined. And for unencrypted messages on the GPRS Abis and on the Gb interface Layer 3 statistics can provide information like *attach request* counts together with information on *attach complete*.

Frame Relay Channel Scanning for Gb Interface

In typical GPRS implementations the Gb interface is a 2 Mbps line carrying several frame relay connections. Each frame relay connection consists of a number of time slots. The CMA 3000 provides a search facility that scans the contents of a monitored 2 Mbps line and identifies the frame relay connections on the line. This way you will easily and rapidly obtain the essential information on the Gb interface configuration.



Please refer to the dedicated spec sheet for detailed information on the CMA 3000 GSM/GPRS A-bis options.

ISDN Protocol Analysis Options

The basic ISDN protocol signaling functions include signaling message monitoring with all-level decode, powerful signaling statistics and easy-to-use filter facilities. With this you are able to analyze a range of international and national ISDN, V5.1/V5.2, QSIG protocols and other access protocols. The instrument allows you to capture signaling information from up to four 64 kbps or up to sixteen 16 kbps signaling channels.

Key applications of the ISDN protocol functionality option include Installation testing, rapid in-service diagnostics and troubleshooting, signaling-link performance and load, protocol analysis and troubleshooting plus signaling-message sequence and call completion analysis.

Measurement functions include supervision of the 2 Mbps line and audio access to the traffic channels, as well as line-status and performance measurement. The CMA 3000 transmitter generates test signals for commissioning tests of 2 Mbps PCM systems. The transmitter also allows drop-and-insert testing for in-service measurement of transmission quality.

Protocol Analysis

During installation or troubleshooting, the CMA 3000's event log provides you with valuable detailed information on the signaling by collecting signaling messages from the connected 2 Mbps line. All layers of the protocol are decoded completely into text (ISDN, V5.x) or mnemonics. The mnemonics can be translated into plain language, and the use and possible values of the field are explained.

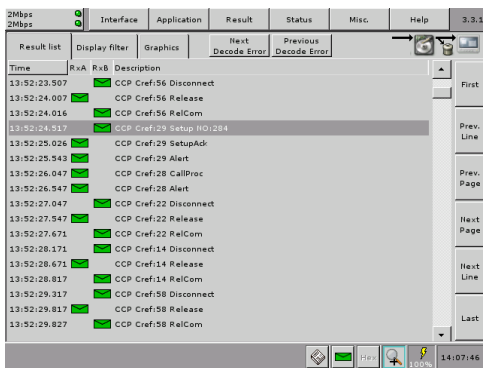

Fig. 39 A Result List presentation of ISDN signaling.

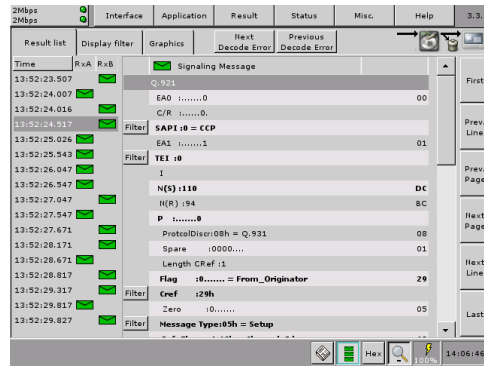

Fig. 40 Detailed presentation of the message contents

The CMA 3000 presents the recorded information in different ways: The Result List gives a one-line indication of each message for a rapid overview of the signaling information. This makes it simple to identify the input on which the message was detected. Intuitive color indications highlight messages that could not be correctly decoded. With the search facility you can easily find such messages. The Result List overview presentation may be expanded to contain a couple of lines per message, stating the most important information in the message. The contents of a message can also be shown, either presenting the main information elements or all parts of the signaling message and the hexadecimal values for detailed inspection and analysis.

Messages are stored in the CMA 3000's memory and can be examined during or after the measurement. Filters can be applied to select the most essential information for storage and display. For ISDN protocols, you may set the filter to display only SETUP messages, providing a quick overview of calls on the line. It's easy to import the Call Reference parameter value to display filters, making the extraction of ISDN messages that belong to the same call a very simple task.

Signaling Statistics

The CMA 3000's signaling statistics provide data on the total traffic load and the quality of the signaling link. For examination of the Layer 2 traffic load on the signaling link, CMA 3000 displays traffic information split into Supervisory (S), Unnumbered (U) and Information frames (I/UI). The ISDN Layer 3 message type statistics provides you with numerous network-optimization opportunities. Call completion can be examined by comparing SETUP messages count on one side of the line with CONNect messages on the other side. Traffic channel load is clearly displayed in a histogram presentation of SETUP message counts. Release cause statistics are also available for the ISDN protocols.

Other Access Protocols

The CMA 3000 supports analysis of other access protocols, such as V5.1/V5.2, QSIG, DPNSS and DASS2. The instrument can capture signaling information from up to four 64 kbps signaling channels. This is particular important when analyzing V5.1/V5.2 systems where the signaling in many cases uses two or three 64 kbps signaling channels.



Please refer to the dedicated spec sheet for detailed information on the CMA 3000 ISDN protocol analysis options.

ISDN PRI Call Emulation

With the ISDN Call Emulation option, the battery-powered CMA 3000 is an easy-to-use, easily transportable test instrument for installation, operation and maintenance of the fixed access network 2 Mbps Primary Rate Interfaces (PRI). The ISDN Call Emulation option provides the necessary functionality for testing ISDN connections. The instrument can setup and receive ISDN calls with user-specified parameters such as called number and facilities. When a connection is setup, a voice call or a BER test can be made. Special facilities allow testing the availability of supplementary services. If ISDN signaling decode options are added, the user gains access to the powerful ISDN protocol functionality of CMA 3000.

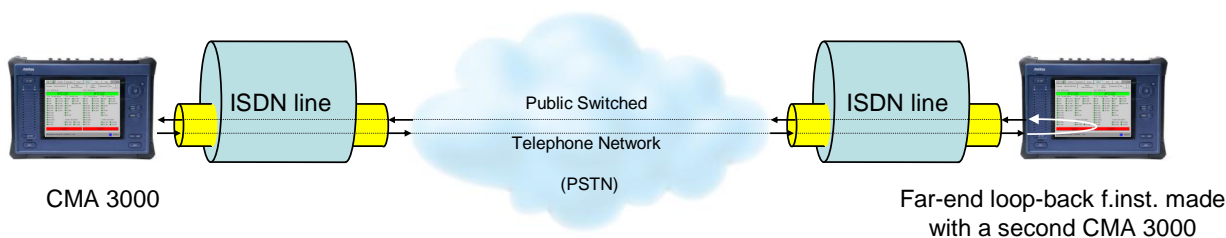

Fig. 41 ISDN call emulation with the CMA 3000.

Call Emulation

The call emulation function permits the user to setup or answer ISDN calls. The user has numerous call setup options which are all easily configured in the call setup display. The number to be called can either be entered on the instrument itself or the optional telephone set. To load an ISDN PRI connection, up to 30 calls can be active at the same time.

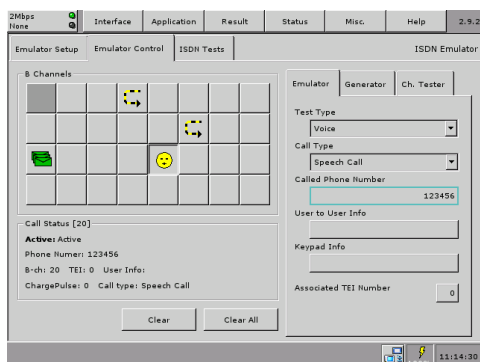

Fig. 42 The status of the emulator will be presented to the user on the Emulator Control page. Calls are activated and answered in the same display.

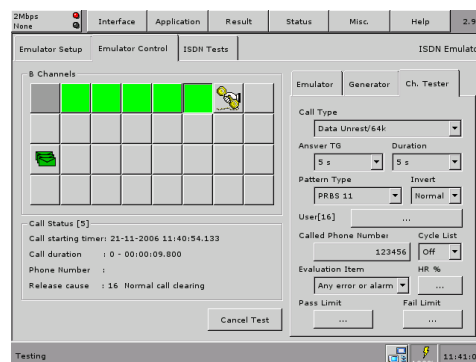

Fig. 43 During and after the channel test the status of the test and the results for the individual channels are displayed in the ISDN channel test status display.

The user has several options for testing an established connection; a conversation with the called party can be carried out on the optional telephone set or by performing a BER test. The BER test can be made with either a far-end loopback or by applying a self-call test. In this case the instrument makes a call to itself using two B-channels. The user can initiate repeated call setups to a set of telephone numbers with the call generator feature, which generates up to 8 concurrent calls. The number(s) called may be those entered into the phone list of the instrument or one entered when the call generator is started. An automated BER test of each of the traffic channels of an ISDN line can be initiated with the ISDN channel test feature. Hereby all B-channels of the line are easily tested for availability and error performance.

Supplementary Service Test

The instrument allows the user to test the availability of supplementary services on an ISDN line. Calls that require a given supplementary service can be made, and the instrument will inform on the availability of the particular service.



Please refer to the dedicated spec sheet for detailed information on the CMA 3000 ISDN PRI call emulation options.

SS7 Protocol Options

Equipped with SS7 protocol options, the CMA 3000 is an easy-to-use, easily transportable test instrument for installation, operation and maintenance of SS7 signaling links. The SS7 protocol options provide the instrument with functions that include message monitoring with decode of all levels, powerful signaling statistics and easy-to-use filter facilities. The decoder options for the instrument supports analysis of wide a range of international (ITU-T, ETSI) and national SS7 protocols including GSM protocols: MAP and A-interface protocols. It captures information from up to four 64 kbps signaling channels in a 2 Mbps link, or if equipped with SDH options, from a 2 Mbps link embedded in the SDH signal.

Applications of the SS7 protocol options include installation testing, rapid in-service diagnostics and troubleshooting, signaling-link performance and load measurements, protocol analysis and troubleshooting plus signaling-message sequence and call completion analysis.

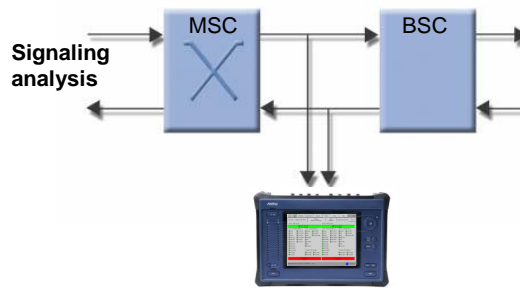

Fig. 44 Bidirectional monitoring of SS7 signaling for protocol analysis with the CMA 3000.

Protocol Analysis

During installation or troubleshooting, the CMA 3000's event log provides valuable, detailed information on the signaling by collecting SS7 signaling messages from the connected links. All layers of the protocol are decoded completely into mnemonics. The mnemonics can be translated to plain language and the use and possible values of the field are explained.

The CMA 3000 presents the recorded information in different ways: The Result List gives a one-line indication of each message, providing a quick overview of the signaling information. Intuitive color indications highlight messages that could not be correctly decoded. A search facility makes it easy to find such messages. The Result List overview presentation may be expanded to provide the most important information in the message. The contents of a message can also be shown, either presenting the main information elements or with information on all parts of the signaling message and the hexadecimal values for detailed inspection and analysis. Messages are stored in the CMA 3000's memory and can be examined during or after the measurement. Filters can be applied to select the most essential information for storage and display.

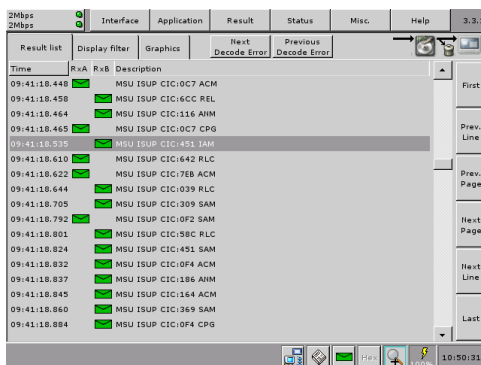

Fig. 45 The Result List presentation of SS7 signaling.

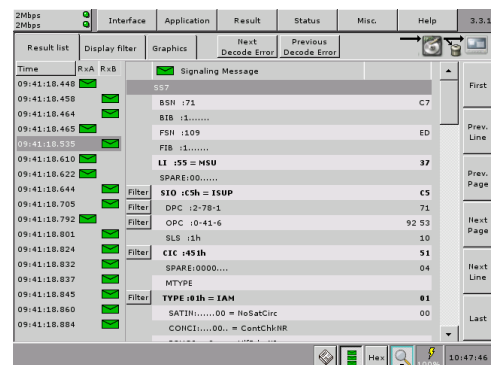

Fig. 46 The detailed presentation of the contents of an SS7 message.

Signaling Statistics

The CMA 3000's signaling statistics provide data on total traffic load and the quality of the signaling link. The instrument can provide information on the SS7 User Parts divided by the SIO value. The SS7 ISUP message statistics open up a vast range of opportunities for network optimization. Call completion in ISUP protocols can be analysed by comparing counts of IAMs on one side of the line with answer messages (ANM) on the other. Release cause statistics are available for ISUP protocols.



Please refer to the dedicated spec sheet for detailed information on the CMA 3000 SS7 protocol functionality options.

Remote Access of the CMA 3000 with FrontSim

For several applications it is relevant to access the instrument remotely. These applications include:

- Remote operation of the instrument
- Long-term surveillance
- Multi-site surveillance
- Display of screens through a projector
- Documentation and training

These applications are easily achieved by running the FrontSim software option on a PC and the CMA 3000. The FrontSim program presents the screens and alarm indicator LEDs of a remote CMA 3000 on a PC. Likewise mouse-clicks on the PC are transferred to the remote instrument. This allows you to operate the CMA 3000 instrument and view results on a PC exactly as had you been working on the instrument itself, only requirement is that both the PC and the CMA 3000 are connected to a LAN or to the Internet. Furthermore measurement result reports and instrument configuration files can be transferred via FrontSim. Finally upgrade of the instrument SW can be made remotely via FrontSim.

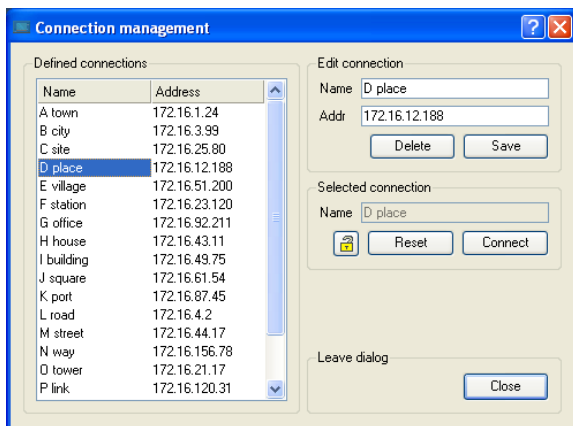

Fig. 47 The connection list provides easy access to instruments located remotely.

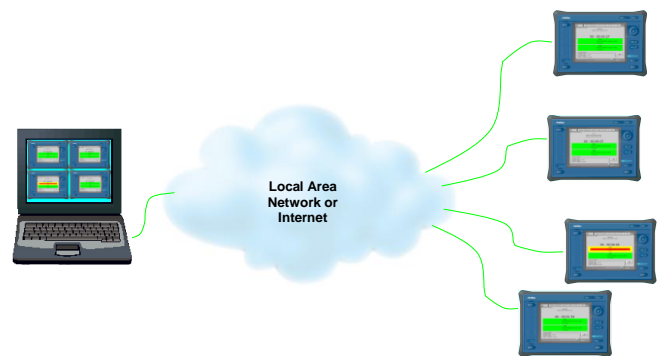

Fig. 48 In compact mode several FrontSim sessions can be monitored simultaneously on the PC screen.

It's possible to open several different FrontSim applications on one PC. This enables you to simultaneously check the results of a number of CMA 3000 instruments from one PC.

With the FrontSim application you can define a list of connections to remote instruments, specifying a connection name and the IP address of each instrument. This is useful when the CMA 3000 instruments have designated fixed IP addresses, making it very easy to access the instruments by simply selecting from the list shown on your PC.



Please refer to the dedicated spec sheet for detailed information on the CMA 3000 Remote access option.

Remote control of the CMA 3000 with scripting

The Remote Control – Scripting option turns the CMA 3000 instrument into a fast, reliable and powerful tool for automated testing in labs and manufacturing environments. During development and manufacturing of communication network elements repeated tests are required to ensure and verify the quality of the products. This is most efficiently done by controlling test instruments from a PC with test scripts that set up the relevant tests, read out the results and do further actions depending on the results. With the Remote Control – Scripting option installed the CMA 3000 is a cost effective and flexible tester for such applications.



Please refer to the dedicated spec sheet for detailed information on the CMA 3000 Remote Control - Scripting option.



Please refer to the CMA 3000 ordering guide for information on ordering codes and how to configure the the CMA 3000.

- **United States**

Anritsu Company

1155 East Collins Blvd., Suite 100, Richardson,
TX 75081, U.S.A.
Toll Free: 1-800-267-4878
Phone: +1-972-644-1777
Fax: +1-972-671-1877

- **Canada**

Anritsu Electronics Ltd.

700 Silver Seven Road, Suite 120, Kanata,
Ontario K2V 1C3, Canada
Phone: +1-613-591-2003
Fax: +1-613-591-1006

- **Brazil**

Anritsu Eletrônica Ltda.

Praça Amadeu Amaral, 27 - 1 Andar
01327-010 – Bela Vista - São Paulo - SP - Brasil
Phone: +55-11-3283-2511
Fax: +55-11-3288-6940

- **Mexico**

Anritsu Company, S.A. de C.V.

Av. Ejército Nacional No. 579 Piso 9, Col. Granada
11520 México, D.F., México
Phone: +52-55-1101-2370
Fax: +52-55-5254-3147

- **United Kingdom**

Anritsu EMEA Ltd.

200 Capability Green, Luton, Bedfordshire LU1 3LU, U.K.
Phone: +44-1582-433200
Fax: +44-1582-731303

- **France**

Anritsu S.A.

12 avenue du Québec, Batiment Iris 1-Silic 612,
91140 VILLEBON SUR YVETTE, France
Phone: +33-1-60-92-15-50
Fax: +33-1-64-46-10-65

- **Germany**

Anritsu GmbH

Nemetschek Haus, Konrad-Zuse-Platz 1
81829 München, Germany
Phone: +49-89-442308-0
Fax: +49-89-442308-55

- **Italy**

Anritsu S.r.l.

Via Elio Vittorini, 129, 00144 Roma, Italy
Phone: +39-6-509-9711
Fax: +39-6-502-2425

- **Sweden**

Anritsu AB

Borgarfjordsgatan 13A, 164 40 KISTA, Sweden
Phone: +46-8-534-707-00
Fax: +46-8-534-707-30

- **Finland**

Anritsu AB

Teknobulevardi 3-5, FI-01530 VANTAA, Finland
Phone: +358-20-741-8100
Fax: +358-20-741-8111

- **Denmark**

Anritsu A/S (Service Assurance)

Anritsu AB (Test & Measurement)

Kay Fiskers Plads 9, 2300 Copenhagen S, Denmark
Phone: +45-7211-2200
Fax: +45-7211-2210

- **Russia**

Anritsu EMEA Ltd.

Representation Office in Russia

Tverskaya str. 16/2, bld. 1, 7th floor.

Russia, 125009, Moscow

Phone: +7-495-363-1694

Fax: +7-495-935-8962

- **United Arab Emirates**

Anritsu EMEA Ltd.

Dubai Liaison Office

PO Box 500413 - Dubai Internet City
Al Thuraya Building, Tower 1, Suit 701, 7th Floor
Dubai, United Arab Emirates
Phone: +971-4-3670352
Fax: +971-4-3688460

- **Singapore**

Anritsu Pte. Ltd.

60 Alexandra Terrace, #02-08, The Comtech (Lobby A)
Singapore 118502
Phone: +65-6282-2400
Fax: +65-6282-2533

- **India**

Anritsu Pte. Ltd.

India Branch Office

2nd & 3rd Floor, #837/1, Binnamangla 1st Stage,
Indiranagar, 100ft Road, Bangalore - 560038, India
Phone: +91-80-4058-1300
Fax: +91-80-4058-1301

- **P.R. China (Shanghai)**

Anritsu (China) Co., Ltd.

Room 1715, Tower A CITY CENTER of Shanghai,
No. 100 Zunyi Road, Chang Ning District,
Shanghai 200051, P.R. China
Phone: +86-21-6237-0898
Fax: +86-21-6237-0899

- **P.R. China (Hong Kong)**

Anritsu Company Ltd.

Unit 1006-7, 10/F., Greenfield Tower, Concordia Plaza,
No. 1 Science Museum Road, Tsim Sha Tsui East,
Kowloon, Hong Kong, P.R. China
Phone: +852-2301-4980
Fax: +852-2301-3545

- **Japan**

Anritsu Corporation

8-5, Tamura-cho, Atsugi-shi, Kanagawa, 243-0016 Japan
Phone: +81-46-296-1221
Fax: +81-46-296-1238

- **Korea**

Anritsu Corporation, Ltd.

502, 5FL H-Square N B/D, 681
Sampyeong-dong, Bundang-gu, Seongnam-si,
Gyeonggi-do, 463-400, Korea
Phone: +82-31-696-7750
Fax: +82-31-696-7751

- **Australia**

Anritsu Pty. Ltd.

Unit 21/270 Ferntree Gully Road, Notting Hill,
Victoria 3168, Australia
Phone: +61-3-9558-8177
Fax: +61-3-9558-8255

- **Taiwan**

Anritsu Company Inc.

7F, No. 316, Sec. 1, Neihu Rd., Taipei 114, Taiwan
Phone: +886-2-8751-1816
Fax: +886-2-8751-1817